

SANYO

CDP-M303

MP3

Instruction Manual

Personal CD Player

CD·MOBILE

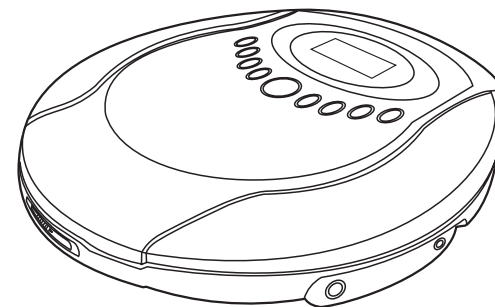

SANYO Canada Inc.

www.sanyocanada.com

SAFETY TIPS

Thank you for purchasing the SANYO CDP M303.

The CDP M303 comes with headphones and an AC adapter.

CAUTIONS FOR SAFETY

Do not take the unit apart. The laser beam used in the unit could harm your eyes.

- ❶ Do not insert pins or other objects inside the unit. This unit is equipped with a safety device which automatically turns the laser beam off when the disc compartment is opened. If a pin or other metal object should get inside the unit, however, this safety device may be deactivated.
- ❷ Do not drop the unit or subject it to strong shocks. Doing so could result in damage.

Do not place the unit in the following locations:

- ❶ Locations where the temperature is high. The cabinet may warp or the unit may otherwise be damaged if it is placed in direct sunlight, near heaters (where the temperature is 140°F/60°C or greater) or in cars with the windows closed. (In the summer, the temperature may get as high as 212°F/110°C or more.) Use the unit within a temperature range of 41°F/5°C to 95°F/35°C.
- ❷ In humid or dusty locations.
- ❸ In locations exposed to heavy vibrations.
- ❹ On unstable or tilted surfaces.

CONDENSATION

If cold water is poured into a glass, water droplets form on the outside of the glass. This is called condensation. Condensation may occur on internal operating parts of the laser pickup.

CONDENSATION OCCURS:

- ❶ When the unit is brought from the outdoors into a warm room, or if it is in a cold room which is heated quickly.
- ❷ In the summer, if the unit is moved suddenly from an air conditioned room or car to a hot or humid location.

SHOULD CONDENSATION OCCUR:

The unit may not operate properly if condensation occurs. Wait for 1 to 2 hours (to allow the internal parts to adjust to the surrounding temperature) before using the unit.

SAFETY TIPS

LASER SAFETY

THIS SET EMPLOYS AN OPTICAL LASER BEAM SYSTEM IN THE CD MECHANISM, DESIGNED WITH BUILT IN SAFEGUARDS. DO NOT ATTEMPT TO DISASSEMBLE. EXPOSURE TO THIS INVISIBLE LASER LIGHT BEAM MAY BE HARMFUL TO THE HUMAN EYE. THIS IS A CLASS 1 LASER PRODUCT. USE OF CONTROLS, ADJUSTMENTS OR PROCEDURES OTHER THAN THOSE SPECIFIED HEREIN, MAY RESULT IN HAZARDOUS LASER LIGHT BEAM EXPOSURE. THIS COMPACT DISC PLAYER SHOULD NOT BE ADJUSTED OR REPAIRED BY ANYONE EXCEPT QUALIFIED SERVICE PERSONNEL. THE LASER MECHANISM IN THE SET CORRESPONDS TO THE STYLUS (NEEDLE) OF A RECORD PLAYER. ALTHOUGH THIS PRODUCT USES A LASER PICK UP LENS, IT IS COMPLETELY SAFE WHEN OPERATED ACCORDING TO DIRECTIONS.

SAFETY INSTRUCTIONS



The lightning flash and arrow head within the triangle is a warning sign alerting you of "dangerous voltage" inside the product.

CAUTION

**RISK OF ELECTRIC SHOCK
DO NOT OPEN**

CAUTION: TO REDUCE THE RISK OF ELECTRIC SHOCK, DO NOT REMOVE COVER (OR BACK). NO USER SERVICEABLE PARTS INSIDE. REFER SERVICING TO QUALIFIED SERVICE PERSONNEL.



The exclamation point within the triangle is a warning sign alerting you of important instructions accompanying the product.

WARNING: TO PREVENT FIRE OR SHOCK HAZARD, DO NOT EXPOSE THIS APPLIANCE TO RAIN OR MOISTURE.

Do not apply oil or petroleum products or solvents to any part of this set.

CAUTION:

Invisible laser radiation when open and interlocks defeated. Avoid exposure to beam.

LOCATIONS OF CONTROLS

- | | |
|----------------------------------|---------------------------------|
| 1. CD DOOR | 10. LCD(Liquid Crystal Display) |
| 2. BACKWARD SKIP/SEARCH BUTTON | 11. VOLUME UP BUTTON |
| 3. ALBUM/10+ BUTTON | 12. LINE OUT JACK |
| 4. CD MODE BUTTON | 13. PHONES JACK |
| 5. CD FORWARD SKIP/SEARCH BUTTON | 14. BATTERY COMPARTMENT BUTTON |
| 6. CD PLAY/PAUSE BUTTON | 15. CD DOOR OPEN SWITCH |
| 7. CD STOP BUTTON | 16. DC INPUT JACK |
| 8. EQ/PROGRAM BUTTON | 17. HOLD SWITCH |
| 9. VOLUME DOWN BUTTON | 18. BASS BOOST SWITCH |

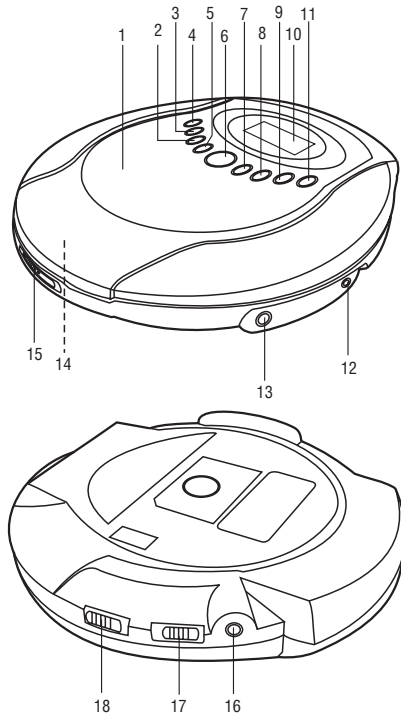

SIGNS IN LCD DISPLAY WINDOW

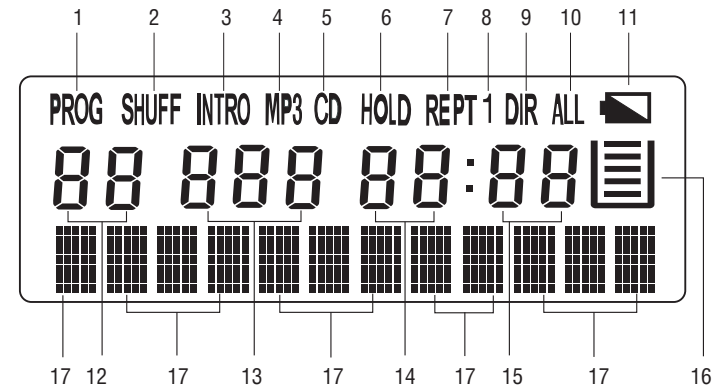

1. "PROG" shows during programmed playing.
2. "SHUFF" shows during random playing.
3. "INTRO" shows during intro scan playing.
4. "MP3" shows when the disc being played is an MP3 disc.
5. "CD" shows when the disc being played is a CD.
6. The "HOLD" will be shown if the hold switch is set to "on" position (optional).
7. "REPT" shows during repeat playing.
8. "REPT 1" shows during single track repeat playing.
9. "REPT DIR" shows during single album tracks repeat playing (only for MP3 disc).
10. "REPT ALL" shows during the whole disc repeat playing.
11. The symbol "  " shows when the unit is running on weak batteries.
12. The current album number during MP3 playing.
13. The number of the track being played.
14. The elapsing minute of the track being played.
15. The elapsing second of the track being played.
16. This symbol shows when the ESP (Electronic skip Protection) function is activated.
17. This is the status column. During MP3 playing, it also shows the playing information of the current track.

POWER SUPPLY

Plug one end of the AC adaptor into the DC IN jack, then plug the other end into AC wall outlet.

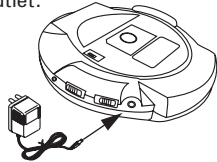

Precautions on using the AC Adaptor

- ❶ Do not touch the AC adaptor with wet hands. Doing so is dangerous, as this could result in an electrical shock.
- ❷ If the AC adaptor is connected when the batteries are installed, the power supply automatically switches to the AC power source and the batteries are disconnected.

NOTE: The plug style of the product may be different from the drawing in the instruction manual, please solve the problem by using your own switching plug.

ALKALINE BATTERY INSTALLATION (NOT SUPPLIED)

Insert two AA batteries (not supplied) into the battery compartment on the bottom of the unit. Be sure to observe the proper polarity (the "+" and "-" signs) as indicated inside the battery compartment.

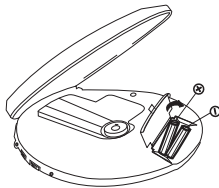

NOTE ON ALKALINE BATTERIES

- ❶ When replacing the alkaline batteries, use two new batteries of the same type. Do not mix a used battery with a new one or mix different types of batteries.
- ❷ When inserting the batteries, mistakenly inserting even one with improper polarity will cause leakage.
- ❸ Never charge, heat, disassemble, or throw batteries into a fire.

REMEMBER

- ❶ If the symbol " " flashes in the display, your batteries are weak. Replace them or use the AC Adapter.
- ❷ If the display is blank — (no numbers show when PLAY/PAUSE button is pushed) the batteries are dead. Replace them or use AC Adapter, or Cigarette Lighter Adapter (Also check if you inserted the batteries according to the "+" and "-" as shown on set).

IMPORTANT NOTE

Spent or discharged batteries must be recycled or disposed of properly in compliance with all applicable laws. For detailed information, contact your local county solid waste authority.

HANDLING COMPACT DISCS

This unit is designed to play compact discs bearing the identification logo (right).



Discs that do not carry this logo may not conform to the CD standard and may not play properly.

Dirty, scratched, or warped discs may cause skipping or noise. Pay attention to the following: Handle the disc only by the edges. To keep the disc clean, do not touch the surface of the disc.

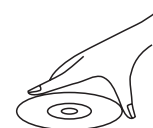

- ❶ Discs should be returned to their cases after use to avoid serious scratches that could cause the laser pickup to skip.
- ❷ Do not expose discs to direct sunlight, high humidity, or high temperatures for extended periods. Prolonged exposure to high temperatures can warp the disc.
- ❸ Do not apply paper or write anything on either side of the compact disc. Sharp writing instruments, or the inks used in

CLEANING DISCS

- ❶ Fingerprints should be wiped from the surface of the disc with a soft cloth. Unlike conventional records, compact discs have no grooves to collect dust and microscopic debris, so gently wiping them with cloth should remove most of the particles. Wipe in a straight motion from the inside to the outside of the disc.

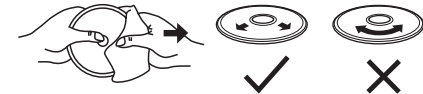

- ❷ Never use such chemicals as record cleaning sprays, anti static sprays, benzene or thinner to clean compact discs. Such chemicals can damage the plastic of the disc.
 - The unit will not play a disc that has been inserted upside down, or discs that do not conform to the Compact Disc standard. Also, the unit might not play discs that are scratched, soiled or carry fingerprints.
 - 3" (8cm) CDs can be played without an adaptor.
 - MP3 discs are handled in the same manner.

PLAYING A CD

Be sure to reduce the volume before plugging in or unplugging the headphones/earphones.

- 1 Plug the cord from a pair of headphones/earphones into the PHONES jack.

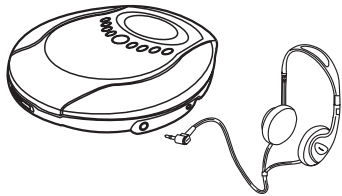

- 2 Slide the OPEN switch to open the CD door.



- 3 Hold the disc with the label side up and press it onto the spindle until it "clicks" into place.

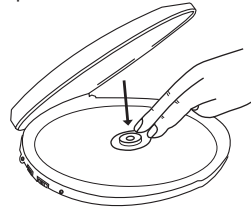

PLAYING A DISC

- 4 Close the CD door, press down PLAY/PAUSE button, and CD begins to spin. Then "READING" appears on the display.

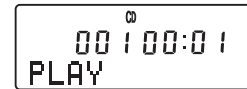
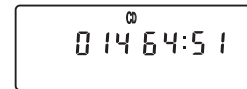

- 5 Adjust the volume as desired.
- 6 Set the Bass Boost function as desired.
- 7 Press PLAY/PAUSE button again to stop playing temporarily.
 - The elapsed playing time would flash on the display.

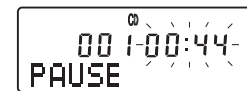

- Resume to normal play by pressing PLAY/PAUSE button.

- 8 If you want to stop playing, press the STOP button. The total number of tracks and total playing time (e.g. A disc contains 10 tracks) will be shown on the display. If you press it again, "POWER OFF" appears, then the power shuts off immediately.

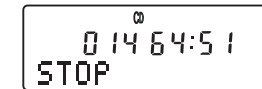

TRACK SEARCH

Press the BACK and FWD SEARCH buttons during play to skip to the desired track.

- 1 Press the ►► button to skip to the next track on the disc.
- 2 Press the ◀◀ button to skip to the beginning of the track currently playing.
- 3 Press the ◀◀ button twice or more to skip to previous tracks.

PLAYING A DISC

FORWARD/REVERSE SEARCH

Press and hold the BACK or FWD SEARCH buttons during play to scan the disc at high speed. When the desired section of the disc is found, release the button. Normal play will resume.

▶▶ FWD.....FORWARD
◀◀ BACK.....REVERSE

- 1 If you press and hold the FWD button while playing, it will scan the current track forward at high speed.
- 2 If you press and hold the BACK button while playing, it will scan the current track backward at high speed.

NOTE: During CD playing, press ALBUM/10+ button once to select the track over +10, adding ten after pressing each time.

ELECTRONIC SKIP PROTECTION SYSTEM

The digital ELECTRONIC SKIP PROTECTION function uses semiconductor memory to prevent the sound from skipping when the unit is subjected to shocks and vibration during play.

- ▶ While the disc begins to play, the "□" indicator appears in the display and the digital ELECTRONIC SKIP PROTECTION function turns on automatically. The digital data is stored in a "read ahead" memory buffer before it is decoded and played. The "□" mark changes to "▣" mark, indicating that the data buffer is full.

- ▶ When the unit is subjected to a shock during play, the data stored in memory continues to be decoded and played. This gives the pickup time to stabilize and continue reading new data. As the data is read from memory the indicator changes to "▣".

- ▶ Once the pickup returns to its original position, new data is stored in memory and the display changes back to the "▣" mark.

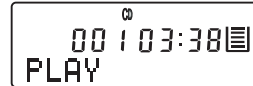
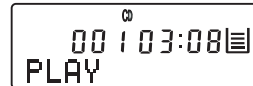
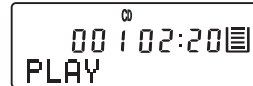
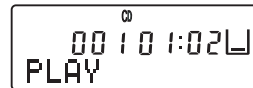

NOTE: The ESP function will start automatically as soon as the player begins to play the disc and is always on.

HOLD SWITCH-HOLD ALL BUTTONS (OPTIONAL)

Once all adjustments/selections are finished, slide the HOLD SWITCH to the ON position, "HOLD" appears on the display. This deactivates all buttons' functions and eliminates the possibility of accidentally pressing buttons. Slide the HOLD SWITCH to the OFF position to unlock all buttons, "HOLD" disappears.

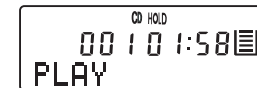

BASS X PANDER™

Use the Bass Boost function to increase the bass output when listening with headphones/earphones.

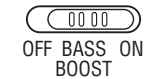

AUTO POWER ON/OFF FUNCTION

AUTO POWER ON FUNCTION

- ▶ The power turns on automatically when the PLAY/PAUSE button is pressed.

AUTO POWER OFF FUNCTION

- ▶ The power turns off automatically when all tracks on a disc have been played or when the STOP button is pressed after approximately 30 seconds.
- ▶ The power turns off immediately when the STOP button is pressed once more.

PROGRAMMED PLAY

The tracks on the disc can be programmed for play in any order (Up to 20 tracks can be programmed).

- 1 Press the EQ/PROGRAM button in stop mode, " **PROG** " and track number " **000** " and program number " **01** " are shown in the display.

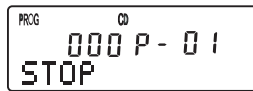

- 2 Press the BACK or FWD SKIP/SEARCH button to select the first track to be programmed.

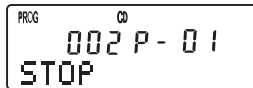

- 3 Press the EQ/PROGRAM button. The first track number is now stored into memory, and the program number changes to " **02** " waiting for your next selection.

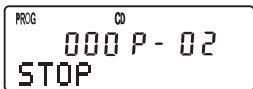

- 4 Repeat steps 2 and 3 to program additional tracks.
- 5 After programming is finished, press the PLAY/PAUSE button.
 - Programmed play begins from the first programmed track.

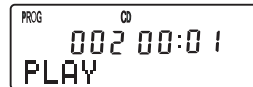

- The player stops automatically after all programmed tracks have been played and the icon " **PROG** " still appears in the display. To program play again, press the PLAY/PAUSE button. The programmed tracks are stored in memory until the disc compartment is opened, the power is turned off, or the STOP button is pressed twice.

INTRO SCANPLAY

- 1 Press the MODE button three times in stop mode or playing mode.
- 2 " **INTRO** " shows in the display; press the PLAY/PAUSE button. The first 10 seconds of each track from track 1 will be played in order.



RANDOM PLAY

RANDOM PLAY

Press the MODE button four times in stop mode or playing mode. " **SHUFF** " shows in the display, press the PLAY/PAUSE button.

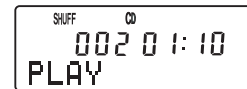

All tracks on the disc will be played in random order selected by CD player, then shut off automatically.

SINGLE TRACK REPEAT/ALL TRACKS REPEAT

SINGLE TRACK REPEAT

Press the MODE button once during play or in stop mode, " **REPT1** " appears in the display, press the BACK or FORWARD SKIP/SEARCH button to select your favourite song (In the stop mode, pressing the Play/Pause button again is required).

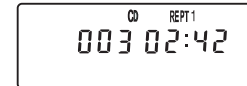

This plays one song repeatedly until you press the STOP button or press the MODE button two times to return to the normal play mode.

ALL TRACKS REPEAT

Press the MODE button twice during play or in stop mode, " **REPT ALL** " shows in the display (In the stop mode, pressing the Play/Pause button again is required).

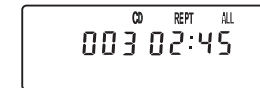

All songs will keep playing in sequence; 1. 2. 3 etc; and all songs will repeat over again until you press the STOP button or press the MODE button one time to return to the normal play mode.

PLAYING AN MP3 DISC

Thank you for choosing the Sanyo CDP M303, CD/MP3 player. Please take a moment to read this instruction booklet so you will become familiar with the many features of this unit.

Note: Because an MP3 disc has a large capacity, the disc reading time will be longer.

Switch on the power, open the CD door, put the disc inside the unit correctly and close the CD door.

Press PLAY/PAUSE, and READING appears on the screen. The disc is read in the following order:

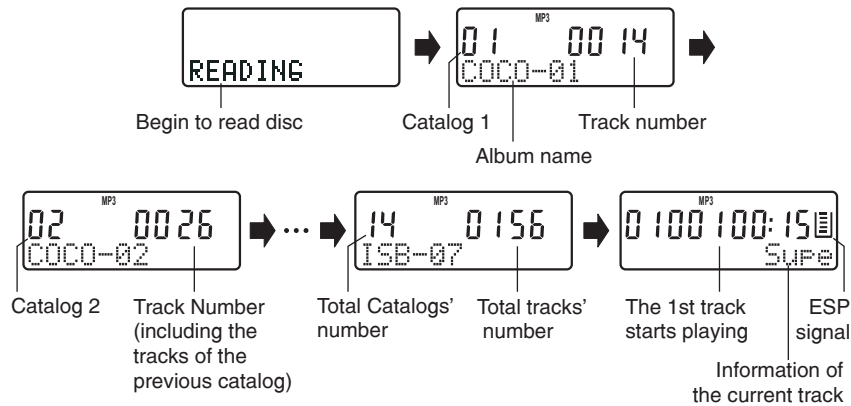

As the diagram above illustrates, the display will show the track number in the context of the entire disc regardless which catalog or album is being played. As an example, if an MP3 disc has 14 catalogs and 156 tracks in total, and catalog 1 has 16 tracks and catalog 2 has 14 tracks, track 26 in catalog 2 would show in the display (as in diagram above).

Instructions for PLAY/PAUSE, STOP/POWER OFF, FORWARD/BACKWARD, etc., are the same for MP3 discs as for CD discs.

NOTE: Because of the anti skip mechanism, the CD stores 120 seconds of play into memory. Therefore, the CD will stop spinning occasionally; listening will not be interrupted.

REPEAT PLAY FUNCTION

SINGLE TRACK REPEAT

During playback, press the MODE button once to repeat the track that is playing. " REPT1 " will appear.



REPEAT ALL

During playback, press the MODE button three times, and the entire disc will be repeated. " REPT ALL " will appear on the display.



REPEAT ALL TRACKS IN CATALOG

During playback, press the MODE button twice to repeat all of the tracks in the current catalogue. " REPT DIR " will appear on the display.



TRACK-SELECTING PLAYBACK

Press FORWARD SKIP/SEARCH (or BACKWARD SKIP/SEARCH) to select the track you wish to play (refer to CD instructions for additional information.)

During playback, press CD ALBUM/10+ to jump in increments of 10 within the current catalog. Then use the forward and backward skip/search to refine your selection.

To select a track in a different catalog, first select the catalog of your choice, and then the track, as follows:

- ❶ Press and hold ALBUM/10+, catalog appears in the display.
- ❷ Press the SKIP/SEARCH to select catalog.
- ❸ Press the ALBUM/10+ again and the first track of the selected catalog appears.
- ❹ Press SKIP/SEARCH to select the exact track of your choice, and then press PLAY/PAUSE

NOTE: Example to follow, selection of track 2 of catalog 9:

- ❶ The first track is in catalog 1 after pressing PLAY/PAUSE, and the display shows as follows:



- ❷ Press and hold ALBUM/10+, the display will show catalog "01".



- ❸ Press SKIP/SEARCH (◀ or ▶) to select catalog 9, and the display shows:



- ❹ Press ALBUM/10+ again, and the 1st track in catalog 9 will flash:



- ❺ Press SKIP/SEARCH to select track 2, and then press PLAY/PAUSE to start playing.



ELECTRONIC EQ SETTING

In PLAY mode, press EQ/PROGRAM repeatedly to select one of DBB (Deep Bass Beat), POP, CLASSIC, JAZ, ROCK or NORMAL.

PROGRAM PLAY (upto 64 tracks can be edited)

NOTE: This can only be done in STOP mode. After pressing STOP, the display will remain active for ____ seconds.

1. In STOP mode, press EQ/PROGRAM.
2. Press SKIP/SEARCH to select desired catalog.
3. Press EQ/PROGRAM again.
4. Press SKIP/SEARCH to select the desired tracks.
5. Repeat the above steps to program the other tracks.
6. Press PLAY/PAUSE to enter program play.

As an example, to select track 3 in catalog 5:

1. In STOP mode, the display shows " 14 " 0156 " .
2. Press EQ/PROGRAM. The display shows " 01000P-01 " and the catalog "01" flashes.
3. Press SKIP/SEARCH to select catalog 5. The display shows "05" .
4. Press EQ/PROGRAM, and the track number " 000 " flashes.
5. Press SKIP/SEARCH to select track 3, and " 003 " appears.
6. Press EQ/PROGRAM again; " P- 02 " appears, ready to select the second track.
7. Repeat the above steps to select the desired tracks.
8. When programming is complete, press PLAY/PAUSE to begin program playing mode.



INTRO SCAN MODE

In stop mode or playing mode, press MODE fourth, "INTRO" flashes on the display. Press PLAY/PAUSE again to begin playing brief introductions to the tracks.

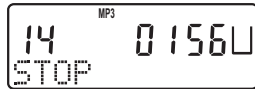

RANDOM PLAY

In STOP or PLAY mode, press MODE five times, and "SHUFF" flashes on the display. Press PLAY/PAUSE again to begin playing the tracks in random order.



SEARCHING SONGS

During MP3 play, songs can be selected by title, as follows:

- 1 In STOP mode, press and hold MODE for a few seconds until "SONG SEARCH" is displayed.
- 2 The letter "A" will then appear. Press SKIP/SEARCH (◀▶) to select the letter or symbol.
- 3 Press MODE to confirm the selected letter or symbol.
- 4 Another letter appears. Continue to select and confirm.
- 5 Press STOP to return to the last letter.
- 6 After the selection is made, press PLAY/PAUSE to play the selected songs.
- 7 If a song is not found, "NOT FOUND" will appear briefly; this will then change to "A".
- 8 To return to normal playback, press "STOP" for a few seconds, and then press PLAY/PAUSE to resume play.

Note: A maximum of 10 characters can be inputted. If more than one song matches the first 10 characters, it will select the first song.



RECORDING FROM THE LINE OUT JACK

The output from the CD player can be easily recorded. Connect a patch cable (not supplied) from the LINE OUT jack on the CD player to the LINE INPUT jacks on a cassette or other recorder.

The sound from the CD can be heard through a pair of speakers. Connect a patch cable (not supplied) from the LINE OUT jack on the CD player to the AUX or CD INPUT jacks on a stereo system.

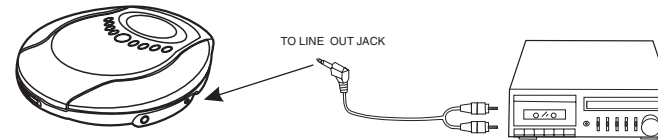

CLEANING

CLEANING THE PICKUP LENS

Dust on the pickup lens can lead to erratic operation and interruption of the sound during play.

- To clean the pickup lens, open the disc compartment. Blow the dust off of the lens using a camera lens blower (available at most camera stores). Do not touch the surface of the lens.

CLEANING THE CABINET

Use a soft cloth moistened with plain lukewarm water and wrung dry. Never use benzol, benzene or other strong chemical cleaners, since these could damage the finish. It is important that no liquid reaches the inside of the unit.

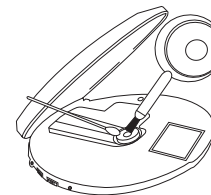

說明書確認標籤

文件名		IB03742-CDM32A-60F8-(AVID 2363 IC)-SANYO-E			
主 控 IC	CD MP3	AVID 2363 IC	安規		制作
	收音		<input type="checkbox"/> AC BIAS		日期 04-17-03
鐘控		<input type="checkbox"/> DC BIAS			
LCD/LED 編碼					
審 核	美工組		設 計 部		
		翻譯		工程師	

注: 該標籤不屬於說明書內容部分
Note: The label does not belong to the text of the instruction manual.

SPECIFICATIONS

PICK UP	
System	Compact disc digital audio system
Laser diode	Material: GaAlAs
Properties	Wavelength: $\lambda = 780\text{nm}$ Emission Duration: continuous Laser output: $< 44.6\mu\text{W}$
Error correction	Cross interleave Reed solomon code
AUDIO	
D/A conversion	1 bit DAC four times oversampling
Frequency response	20 20,000Hz (± 3 dB)
Wow and flutter	Below measurable limits
Bass boost effect (100Hz)	+ 7dB
GENERAL	
No. of channels	2 channels (stereo)
Output level	Line output: 0.6 Vrms (47k Ω) Headphone: 24mW (32 Ω)
Power requirements	2 x LR6 "AA" alkaline battery DC in 4.5V jack accepts AC power adaptor (center positive)
Power consumption	0.8W (DC 4.5V) UNDER NORMAL CONDITION
Dimension	Approx. 143.5(L) x 132.0(W) x 29.3(H)mm
Weight	Approx. 220g (not including battery)
MPEG rate	Supported (32 256) kbps ISO9660, Joliet format compatible.
MP3 playback	ISO9660, Joliet format compatible.
ID3 information	For playing some MP3 disc with ID3 information, the LCD display can show the title of the disc, names of the artists and each song name.
Anti shock	40 sec. for CD. 100 sec. for MP3.
This model is CD R compatible.	

TROUBLE SHOOTING GUIDE

SYMPTOM	CAUSE	SOLUTION
CD Player will not turn on.	Dead or weak batteries. The AC adapter is not connected properly.	Replace both batteries. Check the AC adapter connection at AC outlet and side of set.
Disc will not play.	Disc inserted incorrectly. Defective or wrong type compact disc. CD lid not closed.	Re insert disc with label side facing up. Try another audio compact disc (DVD or data disc won't work). Close lid securely
	Moisture has formed inside the CD deck.	Take out the CD and leave the CD door open for about an hour to dry the moisture condensation.
No sound from headphones.	Headphone plug not inserted properly. Headphone plugged into the LINE out jack. The volume control set to minimum. Weak batteries.	Re insert headphone plug into the headphone jack. Plug headphone into the headphone jack (not the line out jack). Increase the volume. Replace with fresh batteries or use the AC adapter.
	Defective compact disc.	Try another compact disc.
Sound is skipping.	The compact disc or lens is dirty. Too much movement of the CD player. ASR is off.	Clean or replace the compact disc or clean the lens using a camera brush/blower. Reduce movement of CD player. Turn on the ASR.
Sound is distorted.	Music is too loud. Weak batteries.	Decrease the volume control level. Replace both batteries or use the AC adapter.
	BASS X BOOST is on and music is too loud.	Lower volume or slide BASS X BOOST switch to off.
Tracks do not change or set does not play normally.	Batteries are too weak and the battery symbol will show in display.	Replace both batteries. Battery life with new alkaline batteries is about 4 8 hours.
Button do not work.	Electronic or static error caused circuitry to lock.	Remove batteries and AC adapter. Wait a few seconds and re insert. Make sure batteries are fresh or adapter has power.

THE SANYO COMFORT WARRANTY AUDIO PRODUCTS

WARRANTY APPLICATION

New, unused Sanyo Audio products purchased through a Sanyo authorized dealer in Canada are warranted against manufacturing defects in materials and workmanship for ONE YEAR from the date of purchase by the original retail purchaser. This warranty only applies in favour of the original retail purchaser of the warranted product.

SANYO CANADA INC.'S RESPONSIBILITY

During the warranty period, SANYO Canada Inc. will repair, or at our option, replace an Audio product which shows evidence of a manufacturing defect in materials or workmanship.

Replacement PARTS are warranted for the remaining portion of the warranty period.

WHAT IS NOT COVERED

- a) Audio products purchased outside Canada.
- b) Audio products purchased in a used condition.
- c) Problems due to product set-up and installation.
- d) Adjustments that are outlined in the Operating Manual
- e) Accessory items including antenna, batteries and cassette tapes.
- f) Damage in or due to transportation.
- g) Damage due to improper maintenance, improper wiring, accident, abuse, misuse or negligence.
- h) Damage caused by lightning and power surges.
- i) The cost of removal and re-installation of an Audio product designed for automobile use.

ORIGINAL RETAIL PURCHASER'S RESPONSIBILITY

You, the original retail purchaser, must present your original, dated bill-of-sale together with this warranty to SANYO Canada Inc. or to an authorized Sanyo Service Depot when you make a claim under this Warranty.

You, the original retail purchaser, are responsible for any costs of TRANSPORTING the product to and from SANYO Canada Inc. or an authorized Sanyo Service Depot. You also are responsible for the cost

of any MAINTENANCE necessary in respect of the product.

WARRANTY BECOMES VOID

This warranty becomes void if the product's serial numbers are altered or removed or if any repair to the product is made other than by SANYO Canada Inc. or by an authorized Sanyo Service Depot.

LIMITATIONS

- a) SANYO Canada Inc. reserves the right to change or improve the design of the model of the product warranted hereunder without incurring any obligation to make any modifications to or to install any improvement in or on the product.
- b) In no event shall SANYO Canada Inc. or any of its Authorized Dealers be liable for special or consequential damage arising from the use of this product.

STATUTORY WARRANTIES

The above provisions do not preclude the operation of any applicable provincial statute which in certain circumstances may not allow some of the limitations and exclusions described in this Warranty. Where any terms of this Warranty are prohibited by such a statute, they shall be deemed null and void but the remainder of this warranty shall remain in effect.

HOW TO OBTAIN WARRANTY SERVICE

Please contact the Sanyo Authorized Dealer from whom the product was purchased, or contact us directly at:

SANYO Canada Inc.
1-300 Applewood Cres.
Concord, Ont. L4K 5C7
(905) 760-9944
1-800-263-2244